

# Data Sheet



Article number: 54810642042

Description: 2 hole Flange Unit TP-SUCFL204 for shaft  $\varnothing 20\text{mm}$   
Insert stainless steel, housing Thermoplastic white

## Measures

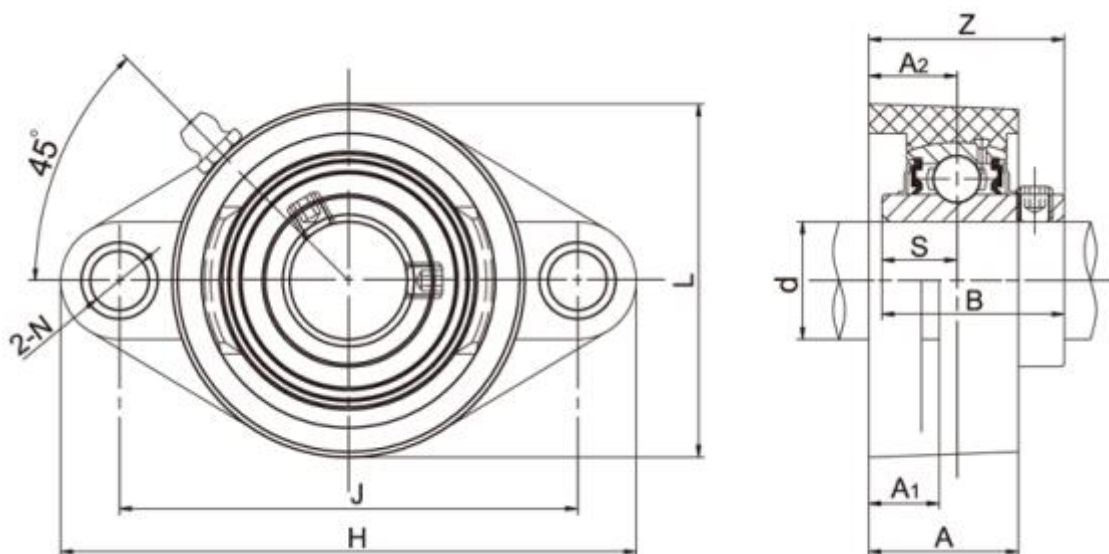

A = 26.5	L = 65
A1 = 14	N = 11
A2 = 15.4	S = 12.7
B = 31	Z = 33.7
Bolt = M10	
d = 20	
H = 113	
J = 90	